

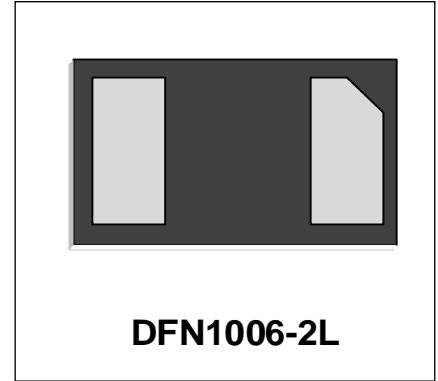

Features

- 36 Watts Peak Pulse Power per Line ($t_p = 8/20\mu s$)
- Protects one I/O or power line
- Low Clamping Voltage
- Working Voltage: 5 V
- Low Leakage Current
- AEC-Q101 Qualified



IEC Compatibility (EN61000-4)

- IEC 61000-4-2 (ESD) $\pm 30kV$ (air), $\pm 30kV$ (contact)
- IEC 61000-4-4 (EFT) 40A (5/50ns)
- IEC 61000-4-5 (Lightning) 3A (8/20 μs)

Mechanical Characteristics

- DFN1006-2L package
- Marking : Marking Code
- Packaging : Tape and Reel per EIA 481
- RoHS Compliant

Applications

- Laptop Computers
- Cellular Phones
- Digital Cameras
- Personal Digital Assistants (PDAs)

Schematic & PIN Configuration

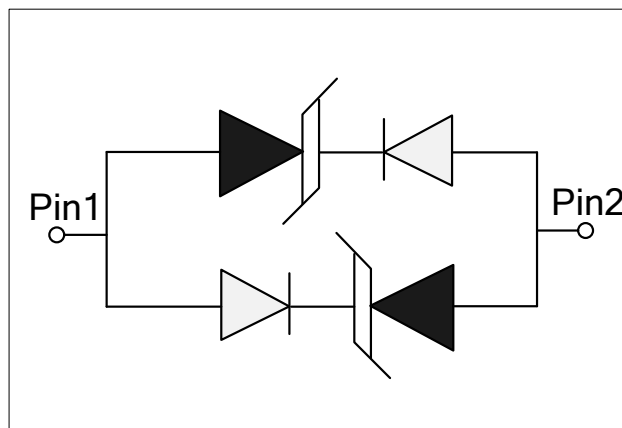

Absolute Maximum Rating

Rating	Symbol	Value	Units
Peak Pulse Power ($t_p=8/20\mu s$)	P_{PP}	36	Watts
Peak Pulse Current ($t_p=8/20\mu s$)	I_{PP}	3	A
Operating Temperature	T_J	-55 to + 125	$^{\circ}C$
Storage Temperature	T_{STG}	-55 to +150	$^{\circ}C$

Electrical Parameters (T=25 $^{\circ}C$)

Symbol	Parameter
I_{PP}	Reverse Peak Pulse Current
V_C	Clamping Voltage @ I_{PP}
V_{RWM}	Reverse Stand-Off Voltage
I_R	Reverse Leakage Current @ V_{RWM}
I_T	Test Current
V_{BR}	Reverse Breakdown Voltage @ I_T

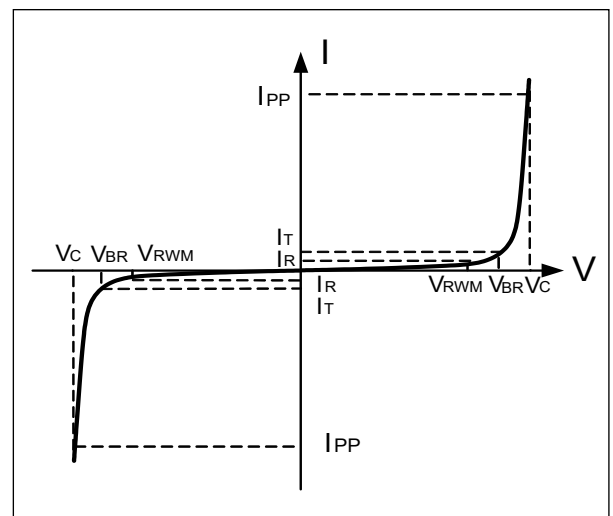

Electrical Characteristics

DW05DUCF-BF-AT-E						
Parameter	Symbol	Conditions	Minimum	Typical	Maximum	Units
Reverse Stand-Off Voltage	V_{RWM}				5	V
Reverse Breakdown Voltage	V_{BR}	$I_T=1mA$	6		9	V
nReverse Leakage Current	I_R	$V_{RWM}=5V, T=25^{\circ}C$			500	nA
Clamping Voltage	V_C	$I_{PP}=3A, t_p=8/20\mu s$		10.5	12	V
Dynamic Resistance ^{1,2}	R_{DYN}	TLP=0.2/100ns		0.6		Ω
ESD Clamping Voltage ¹	V_C	$I_{PP} = 4A,$ $t_p = 0.2/100ns$ (TLP)		9.8		V
ESD Clamping Voltage ¹	V_C	$I_{PP} = 16A,$ $t_p = 0.2/100ns$ (TLP)		17.5		V
Junction Capacitance	C_j	$V_R = 0V, f = 1MHz$		0.4	0.6	pF

Notes : 1、TLP Setting : $t_p=100ns, t_r=0.2ns, I_{TLP}$ and V_{TLP} sample window: $t_1=70ns$ to $t_2=90ns$.

2、Dynamic resistance calculated from $I_{PP}=4A$ to $I_{PP}=16A$ using "Best Fit".

Ver.: A1 2019-02-22 WA



Typical Characteristics

Figure 1: Peak Pulse Power vs. Pulse Time

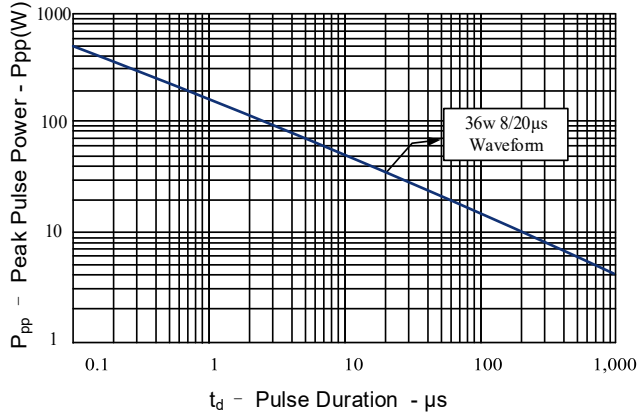

Figure 2: Power Derating Curve

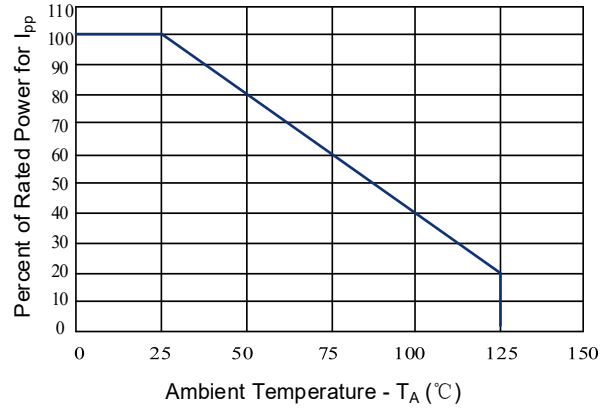

Figure 3: Clamping Voltage vs. Peak Pulse Current

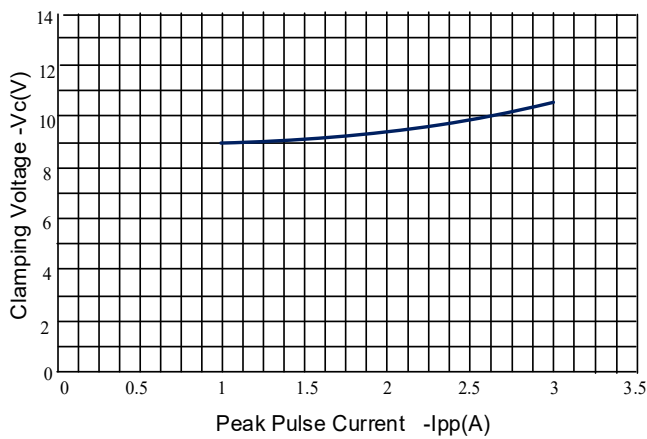

Figure 4: Normalized Junction Capacitance vs. Reverse Voltage

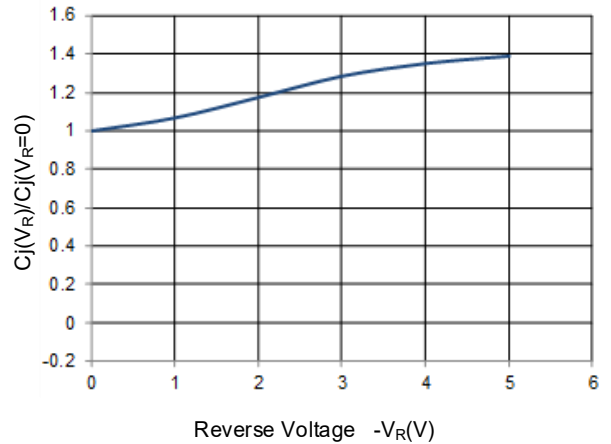

Figure 5: TLP Positive I-V Curve

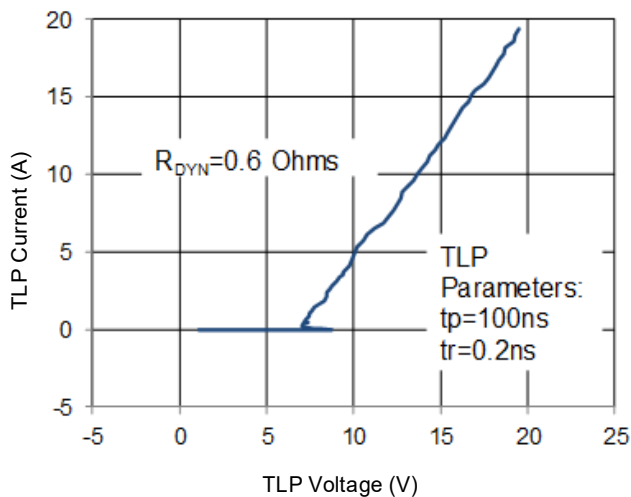
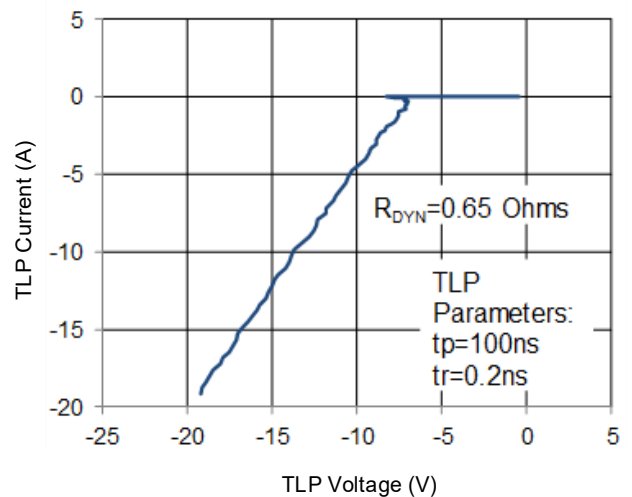

Figure 6: TLP Negative I-V Curve





Soldering Parameters

Reflow Condition		Pb – Free assembly
Pre Heat	Temperature Min ($T_{s(min)}$)	150°C
	Temperature Max ($T_{s(max)}$)	200°C
	Time (min to max) (t_s)	60 – 190 secs
Average ramp up rate (Liquidus Temp) (T_L) to peak		5°C/second max
$T_{s(max)}$ to T_L —Ramp-up Rate		5°C/second max
Reflow	Temperature (T_L) (Liquidus)	217°C
	Temperature (t_L)	60 – 150 seconds
Peak Temperature (T_P)		260+0/-5 °C
Time within actual peak Temperature (t_p)		20 – 40 seconds
Ramp-down Rate		5°C/second max
Time 25°C to peak Temperature (T_P)		8 minutes Max.
Do not exceed		280°C

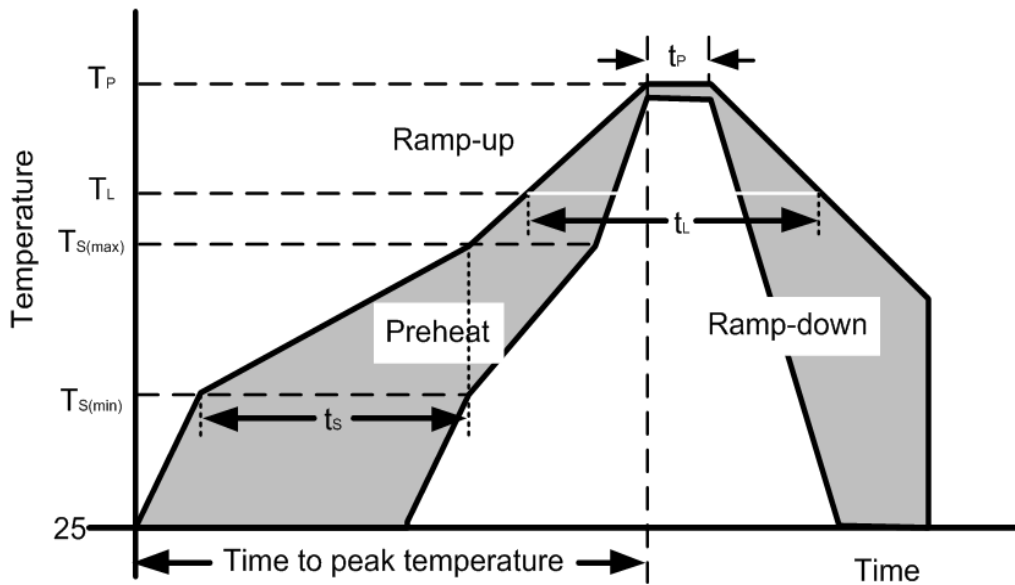



Outline Drawing –DFN1006-2L

PACKAGE OUTLINE

BOTTOM VIEW

DFN1006-2L

SYMBOL	MILIMETER		
	MIN	NOM	MAX
A	0.45	0.50	0.55
A1	0	0.02	0.05
b	0.45	0.50	0.55
C	0.12	0.15	0.18
D	0.95	1.00	1.05
e	0.65BSC		
E	0.55	0.60	0.65
L	0.20	0.25	0.30
L1	0.05REF		
h	0.07	0.12	0.17

Land Pattern

Marking Codes

Part Number	Marking Code
DW05DUCF-BF-AT-E	5 T

Package Information

Qty: 10k/Reel